

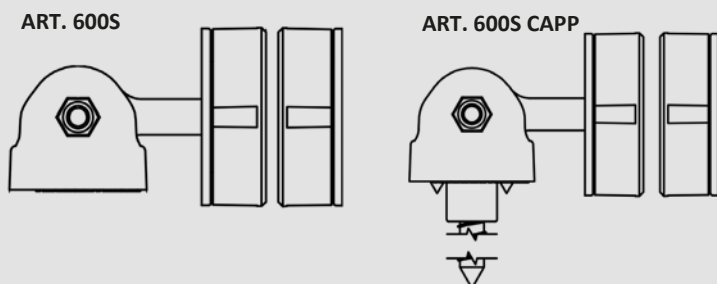

LA NUOVA SERIE

FERMA ANTE MAGNETICI SNODATI

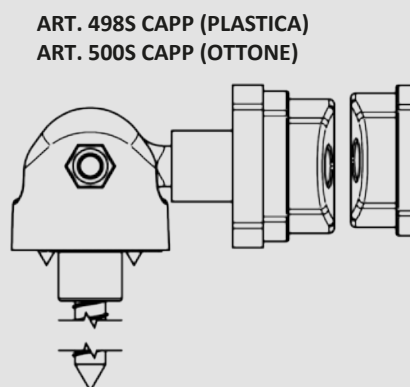
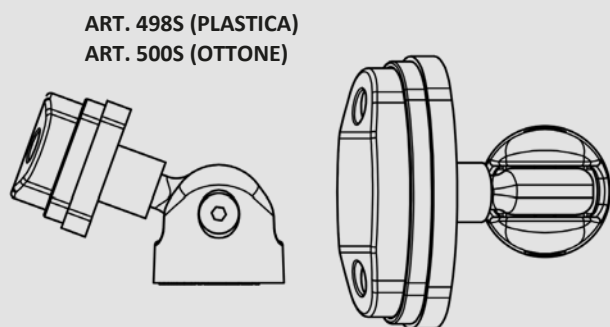
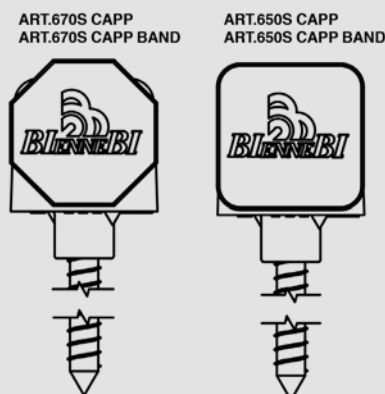
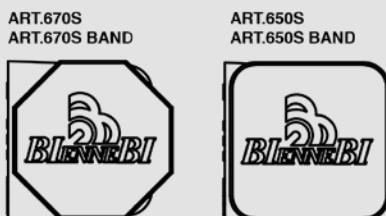
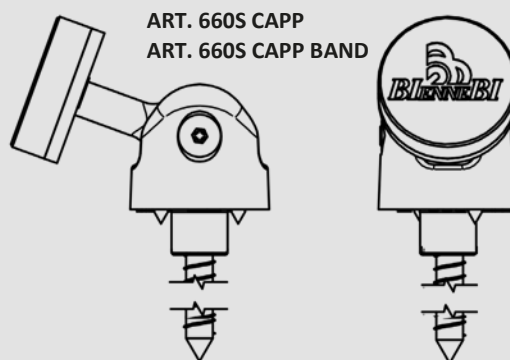
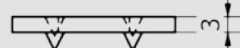

SPessori COMPATIBILI CON L'INTERA
GAMMA DEI FERMA SCURI SNODATI

ART.660A (3MM) 

ART.660B (12MM) 

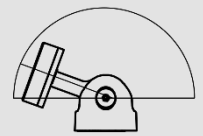

LA NUOVA SERIE

FERMA ANTE MAGNETICI SNODATI

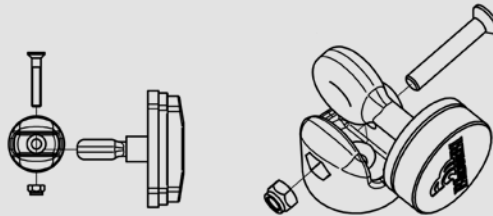

ART. 660S

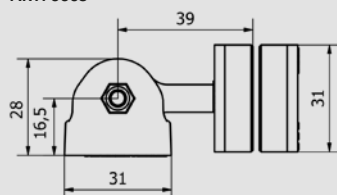

ART. 660S CAPP

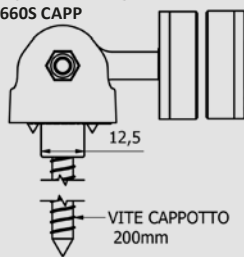
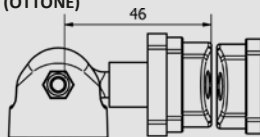
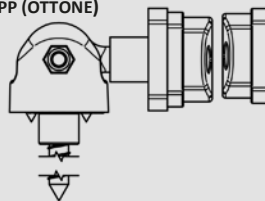
 ART. 498S (PLASTICA)
ART. 500S (OTTONE)

 ART. 498S CAPP (PLASTICA)
ART. 500S CAPP (OTTONE)

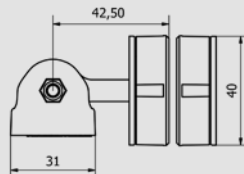
ART. 600S

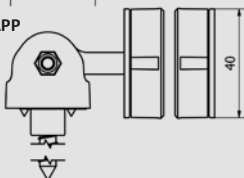

ART. 600S CAPP

 ART.660S
ART.660S BAND

 ART.660S CAPP
ART.660S CAPP BAND

 ART.670S
ART.670S BAND

 ART.670S CAPP
ART.670S CAPP BAND

 ART.650S
ART.650S BAND

 ART.650S CAPP
ART.650S CAPP BAND

Articolo	Pezzi per conf.	Finiture
498S	20	Nero, bianco, verde, grigio alluminio, marrone
498S CAPP	15	Nero, bianco, verde, grigio alluminio, marrone
500S	20	Ott. cromato, laccati (nero lucido, bianco, nero opaco), cromato satinato
500S CAPP	15	Ott. cromato, laccati (nero lucido, bianco, nero opaco), cromato satinato
600S	20	Nero, bianco, verde, grigio alluminio, marrone
600S CAPP	20	Nero, bianco, verde, grigio alluminio, marrone
660S-670S-650S-660S BAND-670S BAND-650S BAND	30	Nero, bianco, verde, grigio alluminio, marrone
660S CAPP-670S CAPP - 650S CAPP - 660S CAPP BAND-670S CAPP BAND-650S CAPP BAND	30	Nero, bianco, verde, grigio alluminio, marrone
SPESSORI 660A-660B	50	Nero, bianco, verde, grigio alluminio, marrone